

A



PROTEKT[®]

CE 0082

EN361:2002

EN Safety harness

B

P-30mX / AB 130 21

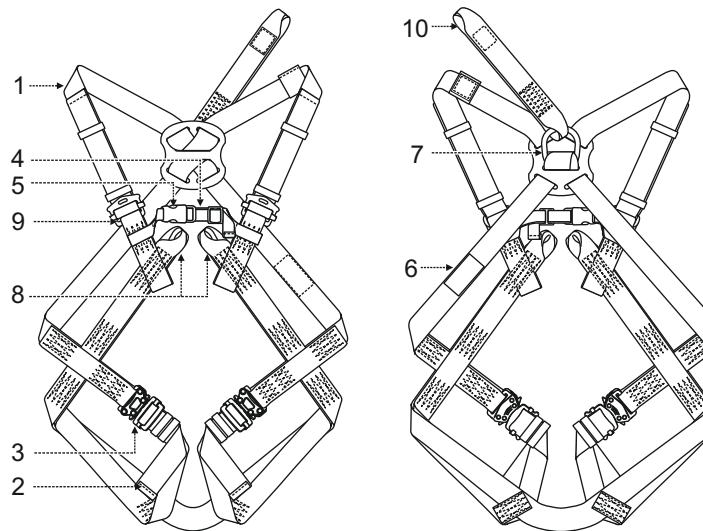

P-30EmX / AB 130 22

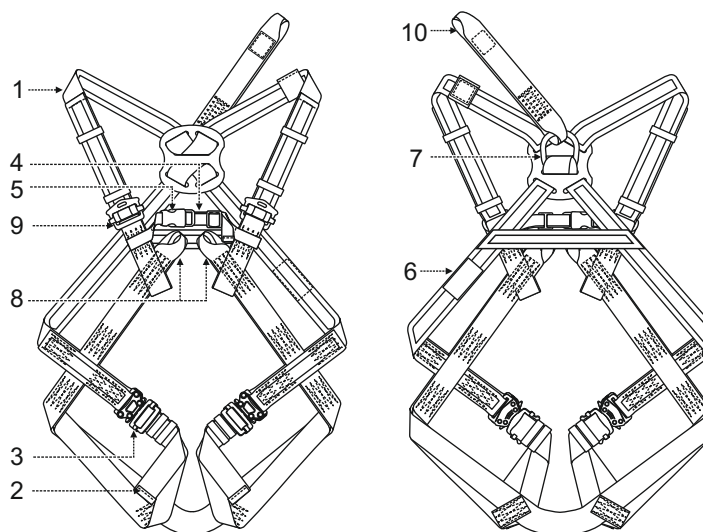

C

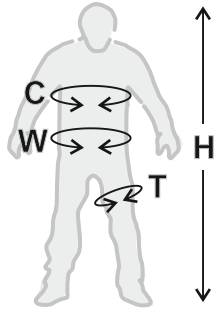

	S	M-XL	XXL	XXXL
H	155 cm - 170 cm	164 cm - 180 cm	180 cm - 195 cm	190 cm - 210 cm
W	75 cm - 110 cm	85 cm - 120 cm	90 cm - 140 cm	95 cm - 150 cm
C	70 cm - 90 cm	85 cm - 100 cm	100 cm - 130 cm	110 cm - 140 cm
T	40 cm - 60 cm	50 cm - 75 cm	60 cm - 85 cm	75 cm - 100 cm

D

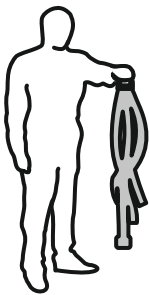

D.1



D.2



D.3



D.4



D.5



EN361

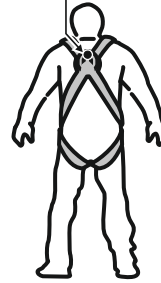

D.6

EN361

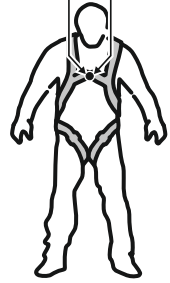

D.7

E

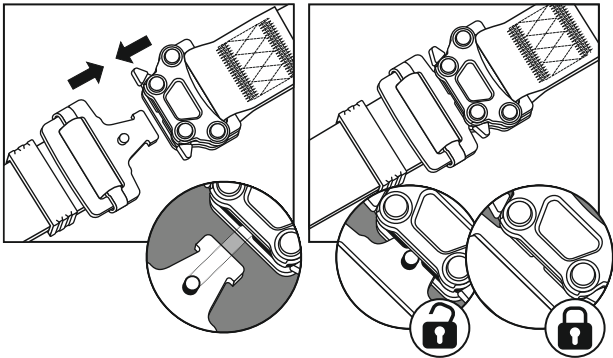
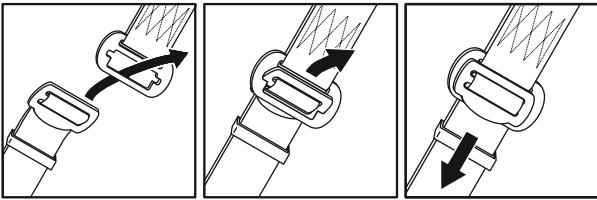

F

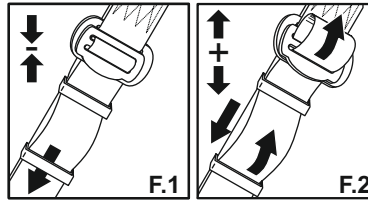

F.1

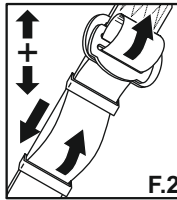

F.2

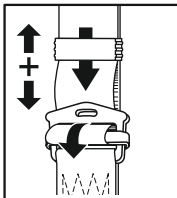
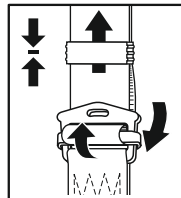
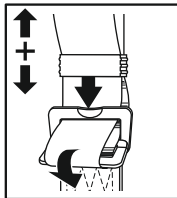
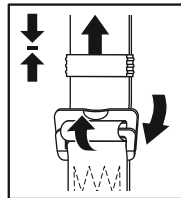
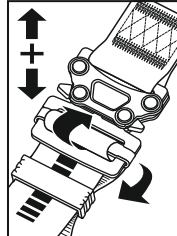
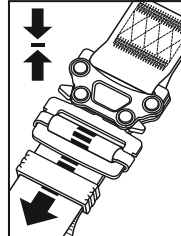

G

- a — P-.....
- b — SAFETY HARNESS
- c — Ref.
- d — Size:
- e — Date of manufacture: MM/YYYY
- f — Serial number: XXX XXX
- g — EN 361:2002
- h — CE 0082
- i —
- j — PROTEKT®

H.1

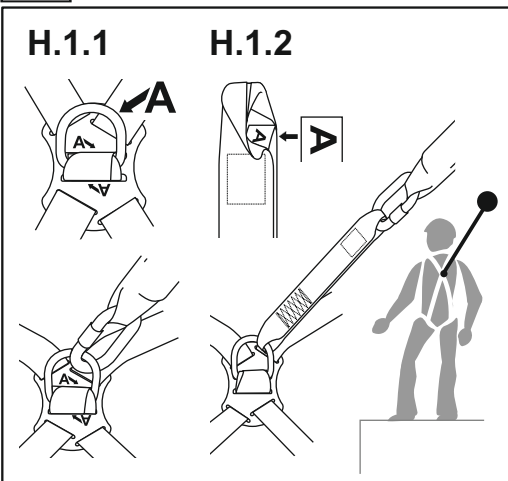

H.1.1

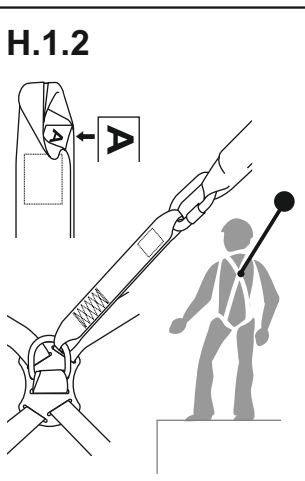

H.1.2

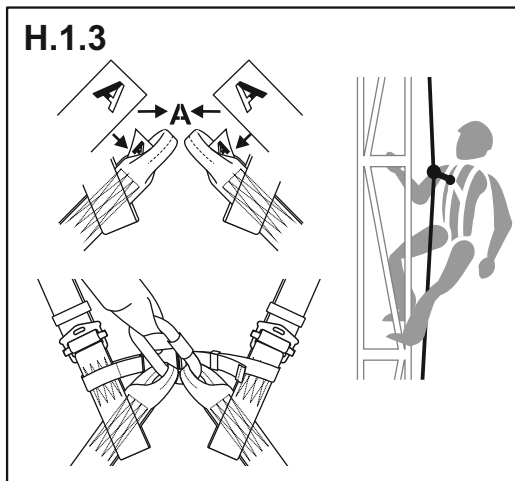

H.1.3

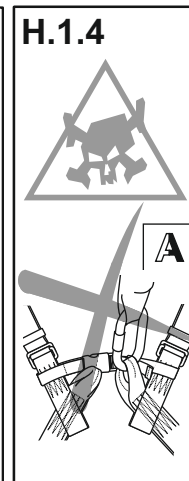

H.1.4

GB - NOTICE: Read and fully understand these instructions before using this equipment.

A. DESCRIPTION

Safety harness is a body holding device which is a component of personal protective equipment described in EN 363 standard intended to protect the user against falls from a height. The harness is approved for a user, including tools and equipment, with a weight of up to 140 kg. Maximum rated load 140 kg for EN361 full body harness is permitted only when energy absorbing element compatible with 140 kg maximum rated load is used. Energy absorbing element must be tested according to Rfu 11.062 or relevant EN standard.

The harness is certified and complying with the standard:

- EN 361:2002 as a full body harness intended to be used in fall arrest systems.

Basic materials:

P-30X

- webbings - polyester
- connecting/adjustment buckles: steel
- attachment D-ring: steel

P-30EX

- webbings - polyester and polyamide (elastic shoulder straps)
- connecting/adjustment buckles: steel
- attachment D-ring: steel

B. NOMENCLATURE

- Shoulder strap.
- Leg strap.
- Leg strap connecting/adjustment buckle.
- Chest strap.
- Chest strap connecting/adjustment buckle.
- Identity label.
- Fall arrest (A) back attachment D-ring EN361.
- Fall arrest (A) frontal attachment loops EN 361.
- Shoulder strap adjustment buckle.
- Fall arrest (A) extension strap EN361.

C. SIZES

The harness is manufactured in four sizes:

- small: S
- universal: M-XL
- extra-large: XXL
- extra, extra-large: XXXL

D. DONNING THE HARNESS:

- Hold the harness by dorsal D-ring. Shake the harness to allow all straps to fall in place.
- Put on the shoulder straps one after one, take care do not twist them.
- Connect and tighten the chest strap.
- Connect and tighten the leg straps. The straps should fit tight around the legs.
- Adjust the shoulder straps so the harness fits the body, not too tight. Free ends of the straps must be kept by the plastic keepers.
- Back attachment D-ring must be positioned between shoulder blades.
- Front attachment D-ring or attachment linked loops must be centred on lower chest.

E. CONNECTING THE BUCKLES

F. ADJUSTING THE STRAPS

- Tightening
- Loosening

G. MEANING OF THE MARKING

- Model symbol;
- Device type;
- Reference number;
- Harness size;
- Month and year of manufacture;
- Serial number of the harness;
- number/year of European standards;
- CE mark and number of the notified body controlling manufacturing of the equipment;
- Caution: read and understand the instruction manual before use;
- identification of the harness manufacturer or distributor

H. ATTACHING THE HARNESS

H.1 ATTACHING FALL ARRESTS SYSTEMS – EN361

Fall arrest system can be attached only to the fall arrest attachment point of full body harness EN 361 marked with capital letter A:

- directly to the back D-ring (H.1.1)
- to extension strap (H.1.2). The length of the extension strap must be taken into consideration when required free clearance below working platform is calculating. The length of the extension strap must be taken into consideration when required free clearance below working platform is calculating. The user should minimise the amount of slack in the strap near a fall hazard. It's forbidden to interleave the extension strap between construction elements or using the strap in the situation when is a risk of falling over the sharp edge (e.g. roof edge).
- to the front attachment loops. The loops marked with a half of letter must be linked together when attached to the fall arrest system (H.1.3). It is strictly forbidden to attach a fall arrest system to a single loop with a half of letter A (H.1.4).

I. PERIODIC INSPECTIONS

Safety harness must be inspected at least once every 12 months from the date of first use. Periodic inspections must only be carried out by a competent person who has the knowledge and training required for personal protective equipment periodic inspections. Depending upon the type and environment of work, inspections may be needed to be carried out more frequently than once every 12 months. Every periodic inspection must be recorded in the Identity Card of the equipment.

J. MAXIMUM LIFESPAN OF THE EQUIPMENT

The maximum lifespan of the harness is 10 years from the date of manufacture.

ATTENTION: The harness maximum lifetime depends on the intensity of usage and the environment of

usage. Using the harness in rough environment, marine environment, contact with sharp edges, exposure to extreme temperatures or aggressive substances, etc. can lead to the withdrawal from use even after one use.

K. WITHDRAWAL FROM USE

The harness must be withdrawn from use immediately and destroyed when it has been used to arrest a fall or if fails to pass inspection or there are any doubt as to its reliability.

L. THE ESSENTIAL PRINCIPLES FOR USERS OF PERSONAL PROTECTIVE EQUIPMENT AGAINST FALLS FROM A HEIGHT:

- personal protective equipment shall only be used by a person trained and competent in its safe use.
- personal protective equipment must not be used by a person with medical condition that could affect the safety of the equipment user in normal and emergency use.
- a rescue plan shall be in place to deal with any emergencies that could arise during the work.
- being suspended in PPE (e.g. arresting a fall), beware of suspension trauma symptoms.
- to avoid symptoms of suspension trauma, be sure that the proper rescue plan is ready for use. It is recommended to use foot straps.
- it is forbidden to make any alterations or additions to the equipment without the manufacturer's prior written consent.
- any repair shall only be carried out by equipment manufacturer or his certified representative.
- personal protective equipment shall not be used outside its limitations, or for any purpose other than that for which it is intended.
- personal protective equipment should be a personal issue item.
- before use ensure about the compatibility of items of equipment assembled into a fall arrest system. Regularly check connecting and adjusting of the equipment components during use to avoid accidental loosening or disconnecting of the components.
- it is forbidden to use combinations of items of equipment in which the safe function of any one item is affected by or interferes with the safe function of another.
- before each use of personal protective equipment it is obligatory to carry out a pre-use check of the equipment, to ensure that it is in a serviceable condition and operates correctly before it is used.
- during pre-use check it is necessary to inspect all elements of the equipment in respect of any damages, excessive wear, corrosion, abrasion, cutting or incorrect acting, especially take into consideration:
 - in full body harnesses and belts - buckles, adjusting elements, attaching points, webbings, seams, loops;
 - in energy absorbers - attaching loops, webbing, seams, casing, connectors;
 - in textile lanyards or lifelines or guidelines - rope, loops, thimbles, connectors, adjusting element, splices;
 - in steel lanyards or lifelines or guidelines - cable, wires, clips, ferrules, loops, thimbles, connectors, adjusting elements;
 - in retractable fall arresters - cable or webbing, retractor and brake proper acting, casing, energy absorber, connector;
 - in guided type fall arresters - body of the fall arrester, sliding function, locking gear acting, rivets and screws, connector, energy absorber;
 - in metallic components (connectors, hooks, anchors) - main body, rivets, gate, locking gear acting.
- after every 12 months of utilization, personal protective equipment must be withdrawn from use to carry out periodical detailed inspection. The periodic inspection must be carried out by a competent person for periodic inspection. The periodic inspection can be carried out also by the manufacturer or his authorized representative.
- in case of some types of the complex equipment e.g. some types of retractable fall arresters the annual inspection can be carried out only by the manufacturer or his authorized representative.
- regular periodic inspections are the essential for equipment maintenance and the safety of the users which depends upon the continued efficiency and durability of the equipment.
- during periodic inspection it is necessary to check the legibility of the equipment marking. Don't use the equipment with the illegible marking.
- it is essential for the safety of the user that if the product is re-sold outside the original country of destination the reseller shall provide instructions for use, for maintenance, for periodic examination and for repair in language of the country in which the product is to be used.
- personal protective equipment must be withdrawn from use immediately when any doubt arise about its condition for safe use and not used again until confirmed in writing by equipment manufacturer or his representative after carried out the detailed inspection.
- personal protective equipment must be withdrawn from use immediately and destroyed (or another procedures shall be introduced according detailed instruction from equipment manual) when it have been used to arrest a fall.
- a full body harness (conforming to EN 361) is the only acceptable body holding device that can be used, in a fall arrest system.
- in full body harness use only attachment points marked with a capital letter "A" to attach a fall arrest system.
- the anchor device or anchor point for the fall arrest system should always be positioned, and the work carried out in such a way, as to minimise both the potential for falls and potential fall distance. The anchor device/point should be placed above the position of the user. The shape and construction of the anchor device/point shall not allowed to self-acting disconnection of the equipment. Minimal static strength of the anchor device/point is 12 kN. It is recommended to use certified and marked structural anchor point complied with EN795
- it is obligatory to verify the free space required beneath the user at the workplace before each occasion of use the fall arrest system, so that, in the case of a fall, there will be no collision with the ground or other obstacle in the fall path. The required value of the free space should be taken from instruction manual of used equipment.
- there are many hazards that may affect the performance of the equipment and corresponding safety precautions that have to be observed during equipment utilization, especially: - trailing or looping of lanyards or lifelines over sharp edges, - any defects like cutting, abrasion, corrosion, - climatic exposure, - pendulum falls, - extremes of temperature, - chemical reagents, - electrical conductivity.
- personal protective equipment must be transported in the package (e.g.: bag made of moisture-proof textile or foil bag or cases made of steel or plastic) to protect it against damage or moisture.
- the equipment can be cleaned without causing adverse effect on the materials in the manufacture of the equipment. For textile products use mild detergents for delicate fabrics, wash by hand or in a machine and rinse in water. For energy absorbers use only a damp cloth to wipe away dirt. It's forbidden to immerse energy absorbers into the water. Plastic parts can be cleaned only with water. When the equipment becomes wet, either from being in use or when due cleaning, it shall be allowed to dry naturally, and shall be kept away from direct heat. In metallic products some mechanic parts (spring, pin, hinge, etc.) can be regularly slightly lubricated to ensure better operation.
- personal protective equipment should be stored loosely packed, in a well-ventilated place, protected from direct light, ultraviolet degradation, damp environment, sharp edges, extreme temperatures and corrosive or aggressive substances.
- Using the harness in connection with personal protective equipment against falls from a height must be compatible with manual instructions of this equipment and obligatory standards: - EN353-1, EN353-2, EN355, EN354, EN360 - for the fall arrest systems;

